

ASAC-1

SOFT STARTER

Issued on 20/12/14

R. 02

- This manual is integrant and essential to the product. Carefully read the instructions contained herein as they provide important hints for use and maintenance safety.
- This device is to be used only for the purposes it has been designed to. Other uses should be considered improper and dangerous. The manufacturer is not responsible for possible damages caused by improper, erroneous and irrational uses.
- Elettronica Santerno is responsible for the device in its original setting.
- Any changes to the structure or operating cycle of the device must be performed or authorized by the Engineering Department of Elettronica Santerno.
- Elettronica Santerno assumes no responsibility for the consequences resulting by the use of non-original spareparts.
- Elettronica Santerno reserves the right to make any technical changes to this manual and to the device without prior notice. If printing errors or similar are detected, the corrections will be included in the new releases of the manual.
- The information contained herein is the property of Elettronica Santerno and cannot be reproduced. Elettronica Santerno enforces its rights on the drawings and catalogues according to the law.

Contents

1	Caution Statements	2
2	Mechanical Installation	2
2.1	Dimensions and Weights	2
2.2	Physical Installation.....	3
3	Electrical Installation	3
3.1	Power Terminations	3
3.2	Control Voltages.....	3
3.3	Control Circuits.....	4
3.4	Outputs.....	4
3.5	Electrical Schematics	5
4	Adjustments	5
5	Troubleshooting	7
5.1	LEDs.....	7
5.2	Trip Codes.....	7
5.3	Protections	7
5.4	Reset.....	8
6	Accessories	8
6.1	Finger Guard Kit.....	8
6.2	Remote Operator.....	8
6.3	Communication Modules.....	8
6.4	PC Software	9
7	Specifications	9
7.1	Semiconductor Fuses	9
7.2	General Technical Data	10
7.3	Model Code.....	11



1 Caution Statements

Caution Statements cannot cover every potential cause of equipment damage but can highlight common causes of damage. It is the installer's responsibility to read and understand all instructions in this manual prior to installing, operating or maintaining the equipment, to follow good electrical practice including applying appropriate personal protective equipment and to seek advice before operating this equipment in a manner other than as described in this manual.

- Isolate the ASAC-1 completely from the power supply before attempting any work on the ASAC-1 or motor.
- Cables to the control inputs must be segregated from mains voltage and motor cabling.
- Some electronic contactor coils are not suitable for direct switching with PCB mount relays. Consult the contactor manufacturer/supplier to confirm suitability.
- Do not apply incorrect voltages to the control input terminals.
- Do not connect power factor correction capacitors to the output of ASAC-1 soft starters. If static power factor correction is employed, it must be connected to the supply side of the soft starter.

The examples and diagrams in this manual are included solely for illustrative purposes. The information contained in this manual is subject to change at any time and without prior notice. In no event will responsibility or liability be accepted for direct, indirect or consequential damages resulting from the use or application of this equipment.



WARNING - ELECTRICAL SHOCK HAZARD

The ASAC-1 contains dangerous voltages when connected to mains voltage. Only a qualified electrician should carry out the electrical installation. Improper installation of the motor or the ASAC-1 may cause equipment failure, serious injury or death. Follow this manual and local electrical safety codes.



GROUNDING AND BRANCH CIRCUIT PROTECTION

It is the responsibility of the user or person installing the ASAC-1 to provide proper grounding and branch circuit protection according to local electrical safety codes.



SHORT CIRCUIT

The ASAC-1 is not short circuit proof. After severe overload or short circuit, the operation of the ASAC-1 should be fully tested by an authorised service agent.

2 Mechanical Installation

2.1 Dimensions and Weights

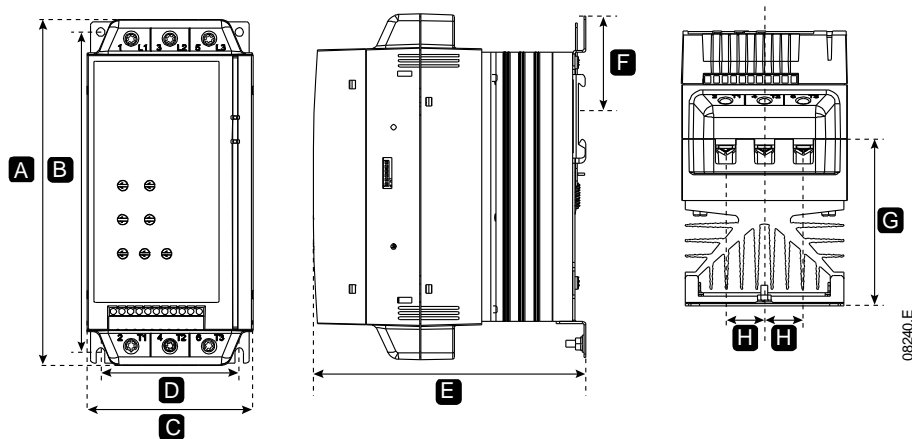

Model	Height mm (inch)		Width mm (inch)		Depth mm (inch)	mm (inch)	mm (inch)	mm (inch)	Weight kg (lb)
	A	B	C	D	E	F	G	H	
ASAC-1//007									
ASAC-1//015									
ASAC-1//018	201	188	98	82	165	55	90.5	23	2.2
ASAC-1//022	(7.91)	(7.40)	(3.85)	(3.22)	(6.49)	(2.16)	(3.6)	(0.9)	(4.85)
ASAC-1//030									
ASAC-1//037									
ASAC-1//045	215	196	145	124	193	-	110.5	37	4.0
ASAC-1//055	(8.46)	(7.71)	(4.88)	(7.59)	(7.59)		(4.4)	(1.5)	(8.81)
ASAC-1//075									
ASAC-1//090	240	216	200	160	214	-	114.5	51	6.5
ASAC-1//110	(9.44)	(8.50)	(7.87)	(6.29)	(8.42)		(4.5)	(2.0)	(14.33)

2.2 Physical Installation

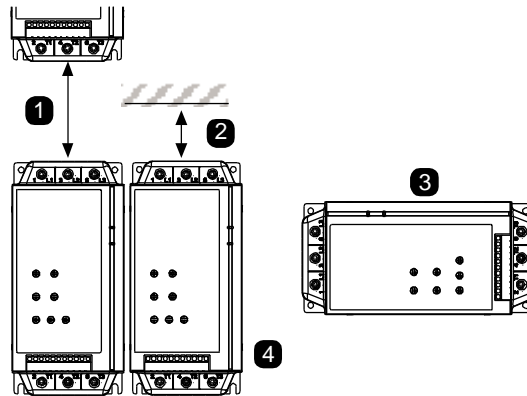

1	ASAC-1/007 ~ ASAC-1/055: Allow 100 mm (3.9 inch) between soft starters. ASAC-1/075 ~ ASAC-1/110: Allow 200 mm (7.9 inch) between soft starters.
2	ASAC-1/007 ~ ASAC-1/055: Allow 50 mm (2.0 inch) between the soft starter and solid surfaces. ASAC-1/075 ~ ASAC-1/110: Allow 200 mm (7.9 inch) between the soft starter and solid surfaces.
3	Soft starters may be mounted side by side with no clearance (that is, if mounted without communications modules).
4	The soft starter may be mounted on its side. Derate the soft starter's rated current by 15%.

3 Electrical Installation

3.1 Power Terminations

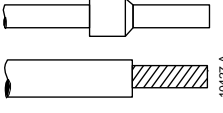
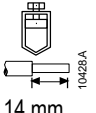
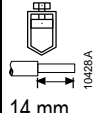
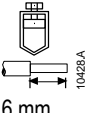
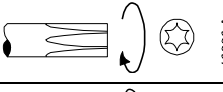
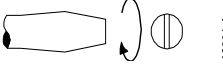
	L1/1, L2/3, L3/5, T1/2, T2/4, T3/6 mm ² (AWG)			A1, A2, A3, 01, 02, B4, B5, 13, 14, 23, 24 mm ² (AWG)
	007 - 030	037 - 055	075 - 110	007 - 110
 10427.A	10 - 35 (8 - 2)  14 mm (0.55 inch)	25 - 50 (4 - 1/10)  14 mm (0.55 inch)	N.A.	 0.14 - 1.5 (26 - 16) 6 mm (0.24 inch)
 10280.A	Torx (T20) 3 Nm 2.2 ft-lb	Torx (T20) 4 Nm 2.9 ft-lb	N.A.	N.A.
 10281.A	7 mm 3 Nm 2.2 ft-lb	7 mm 4 Nm 2.9 ft-lb	N.A.	3.5 mm 0.5 Nm max 4.4 in-lb max

3.2 Control Voltages

ASAC-1 soft starters can be supplied in either of two control voltage configurations:

ASAC-1/xxx/xx/1 110-240 VAC (+ 10% / - 15%) or 380-440 VAC (+ 10% / - 15%)

ASAC-1/xxx/xx/2 24 VAC/VDC (\pm 20%)



WARNING

Always apply control voltage before (or with) mains voltage.



CAUTION

With 24 VAC/VDC use contacts rated for low voltage and low current (gold flash or similar).

3.3 Control Circuits

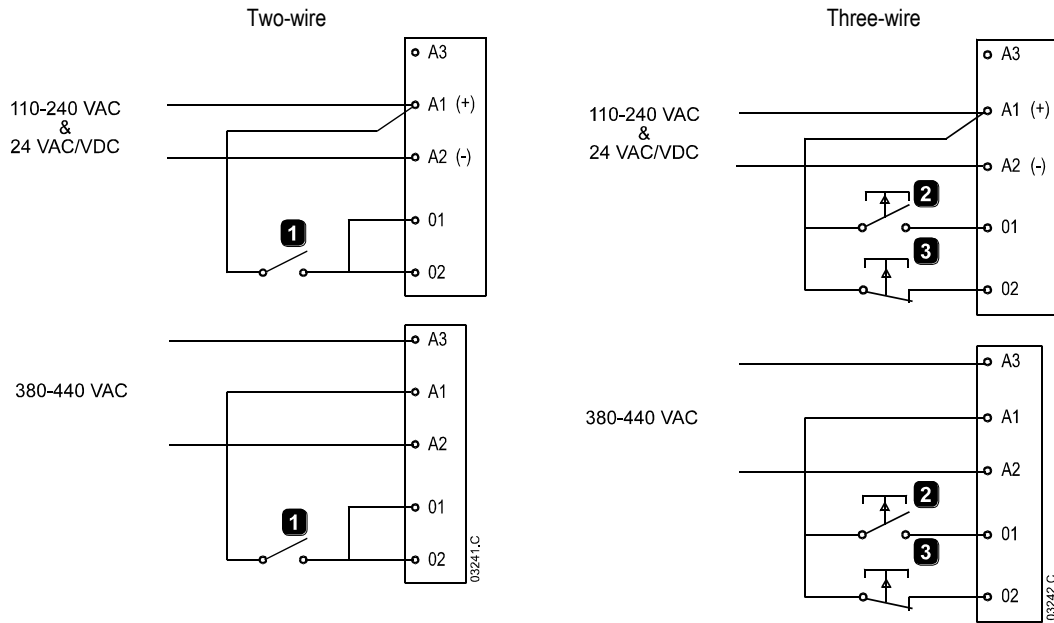

3.3.1 Motor Thermistor

Motor thermistors can be connected directly to the ASAC-1 terminals B4, B5. If motor thermistors are not used, there must be a link between B4, B5 (the ASAC-1 is supplied with a link fitted).

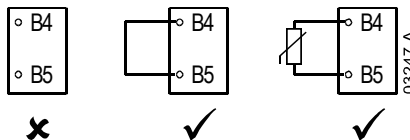

WARNING

Isolate the ASAC-1 completely from the power supply before attempting any work on the ASAC-1 or motor. Control terminals may be at phase voltage potential.



CAUTION

For ASAC-1/xxx/x/2 (24VAC/VDC control voltage) units you can connect an external 24 VDC supply into the control input terminals 01, 02.

3.4 Outputs

3.4.1 Main Contactor Output

The Main Contactor output (terminals 13, 14) closes as soon as the soft starter receives a start command and remains closed while the soft starter is controlling the motor (until the motor starts a coast to stop, or until the end of a soft stop). The Main Contactor output will also open if the soft starter trips.

The Main Contactor output can be used to directly control a main contactor coil.

3.4.2 Programmable Output

The programmable output relay (terminals 23, 24) can be used to signal either trip or run status. This relay is normally open.

Trip:

The relay closes when the ASAC-1 trips. The relay can be used to operate the shunt-trip mechanism of an upstream circuit breaker (in order to isolate the motor branch circuit), or to signal the trip to an automation system or externally. The relay will open when the trip is reset.

Run:

The relay operates when the soft start is complete, the bypass relays are closed and full voltage is being applied to the motor. The relay can be used to operate a contactor for power factor correction capacitors, or to signal soft starter run status to an automation system.

3.5 Electrical Schematics

Soft starter installed with a system protection circuit breaker complete with a shunt trip device

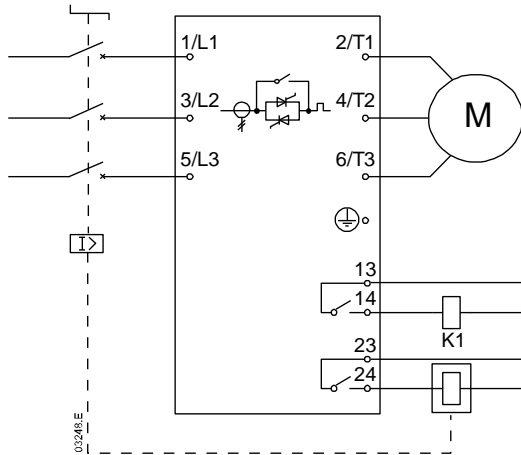

Soft starter installed with a system protection circuit breaker and main contactor

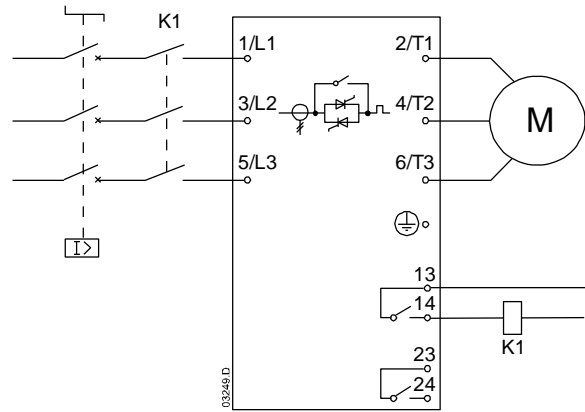

M	Motor (three phase)
K1	Main contactor
13, 14	Main contactor output
23, 24	Programmable output (set to Trip)

4 Adjustments

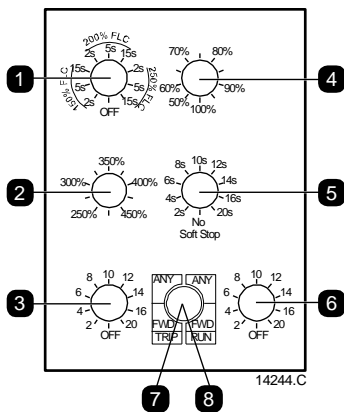

1	Current Ramp
2	Current Limit
3	Motor Trip Class
4	Motor FLC
5	Soft Stop Time
6	Excess Start Time
7	Auxiliary Relay Function
8	Phase Sequence Protection

1 Current Ramp

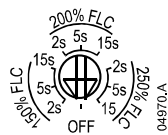

Select the initial start current (A) and ramp time (B). Current ramp starting extends the time soft starter takes to reach the current limit and is suitable for generator set supplies, loads requiring an extended start time or applications with extreme load variation between starts. The ramp time does not control the time the motor will take to reach full speed.

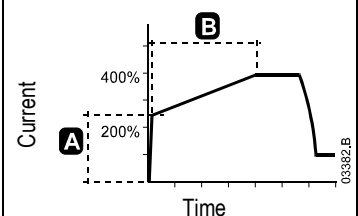

2 Current Limit



Select the current limit (C). The current limit is the maximum level of current the soft starter will deliver to the motor during the soft start.

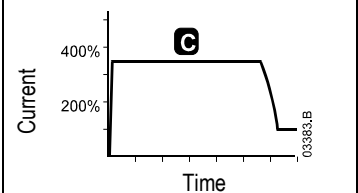

<p>3 Motor Trip Class</p>	<p>Select the trip class for motor overload protection. The trip class reflects the maximum time (in seconds) that the motor can run at locked rotor current. The Motor Trip Class setting assumes a locked rotor current of 600%.</p> <p>Setting the motor trip class to "Off" disables motor overload protection.</p>													
<p>4 Motor FLC</p>	<p>Configure the soft starter to match the motor's full load current (FLC). Configure according to the motor's nameplate current. Divide the motor's FLC by the soft starter's maximum current rating (on the soft starter's nameplate label).</p>	<table border="1"> <tr> <td>INPUT PHASE:</td> <td>3-Phase, 50/60 Hz, 3-Ph</td> </tr> <tr> <td>OUTPUT FLC:</td> <td>0.5-2.0 x 220/230/240 VA @ 30V/DC Resistive</td> </tr> <tr> <td>AUXILIARY CONTACTS:</td> <td>2 x 220VAC/30VA, 5A @ 30V/DC Resistive</td> </tr> <tr> <td>WITHSTAND CURRENT:</td> <td>300A RMS, 600VAC max.</td> </tr> <tr> <td>POWER CONTACTS:</td> <td>#10 - #2 AWG, 6 - 35 mm² (3-5 Nm, 2.2-3.7 lb-in)</td> </tr> <tr> <td>AUXILIARY CONTACTS:</td> <td>20 - 16 AWG, 0.75 - 1.5 mm² (0.5 Nm, 4.5 lb-in)</td> </tr> </table>	INPUT PHASE:	3-Phase, 50/60 Hz, 3-Ph	OUTPUT FLC:	0.5-2.0 x 220/230/240 VA @ 30V/DC Resistive	AUXILIARY CONTACTS:	2 x 220VAC/30VA, 5A @ 30V/DC Resistive	WITHSTAND CURRENT:	300A RMS, 600VAC max.	POWER CONTACTS:	#10 - #2 AWG, 6 - 35 mm ² (3-5 Nm, 2.2-3.7 lb-in)	AUXILIARY CONTACTS:	20 - 16 AWG, 0.75 - 1.5 mm ² (0.5 Nm, 4.5 lb-in)
INPUT PHASE:	3-Phase, 50/60 Hz, 3-Ph													
OUTPUT FLC:	0.5-2.0 x 220/230/240 VA @ 30V/DC Resistive													
AUXILIARY CONTACTS:	2 x 220VAC/30VA, 5A @ 30V/DC Resistive													
WITHSTAND CURRENT:	300A RMS, 600VAC max.													
POWER CONTACTS:	#10 - #2 AWG, 6 - 35 mm ² (3-5 Nm, 2.2-3.7 lb-in)													
AUXILIARY CONTACTS:	20 - 16 AWG, 0.75 - 1.5 mm ² (0.5 Nm, 4.5 lb-in)													
<p>5 Soft Stop Time</p>	<p>Select the soft stop ramp time (D). Soft stop extends the time soft starter takes to reduce voltage to zero. The ramp time does not control the time the motor will take to stop completely.</p>													
<p>6 Excess Start Time</p>	<p>Configure the soft starter's excess start time protection. Select a time slightly longer than the motor requires for a normal healthy start. The soft starter will trip if the start does not complete within the selected time (E).</p>													
<p>7 Auxiliary Relay Function</p>	<p>Select the function of the soft starter's programmable output (terminals 23, 24). When set to "Run", the relay will operate when the soft start is complete. When set to "Trip", the relay will operate when the soft starter trips.</p>													
<p>8 Phase Sequence Protection</p>	<p>Configure the soft starter's phase sequence protection. Select the allowable phase sequences. A setting of "Fwd" allows forward sequence (positive rotation) only and a setting of "Any" defeats the protection.</p>	<table border="1"> <thead> <tr> <th></th> <th>FWD</th> <th>ANY</th> </tr> </thead> <tbody> <tr> <td>L1 L2 L3</td> <td> ✓</td> <td>✓</td> </tr> <tr> <td>L1 L2 L3</td> <td> ✗</td> <td>✓</td> </tr> </tbody> </table>		FWD	ANY	L1 L2 L3	✓	✓	L1 L2 L3	✗	✓			
	FWD	ANY												
L1 L2 L3	✓	✓												
L1 L2 L3	✗	✓												



NOTE

Auxiliary relay function and phase sequence are configured using a shared switch. Set the auxiliary relay function as required, then set phase sequence protection.

5 Troubleshooting



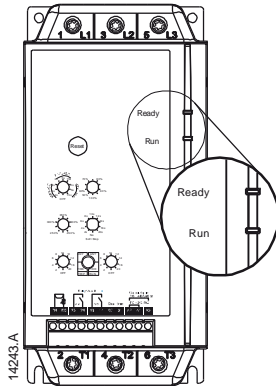







5.1 LEDs



LED Status	Ready	Run
Off	No control power	Motor not running
On	Ready	Motor running at full speed
Flash	Starter tripped	Motor starting or stopping

5.2 Trip Codes

The Ready LED will flash a different number of times to indicate the cause of the trip.

Ready LED	Description
 x 1	Power Circuit: Check mains supply (L1, L2, L3), motor circuit (T1, T2, T3), soft starter SCRs and bypass relays.
 x 2	Excess Start Time: Check load, increase Current Limit or adjust Excess Start Time setting.
 x 3	Motor Overload: Allow motor to cool, reset soft starter and restart. The soft starter cannot be reset until the motor has cooled.
 x 4	Motor Thermistor: Check motor ventilation and thermistor connection B4, B5. Allow motor to cool.
 x 5	Current imbalance: Check for mains supply or line current imbalance (L1, L2, L3).
 x 6	Supply Frequency: Check mains voltage is available and supply frequency is in range.
 x 7	Phase sequence: Check for correct phase sequence.
 x 8	Network Communication Failure (between module and network): Check network connections, settings and configuration.
 x 9	Starter Communication Failure (between starter and module): Remove and refit accessory module.
 x 10	Bypass Overload: Starter rating may be too low for the application.

5.3 Protections

The ASAC-1 includes the following types of protection for the motor and starter:

5.3.1 Excess Start Time Protection

The ASAC-1 will trip on excess start time if the motor does not successfully start within the time selected in the Excess Start Time setting. This may indicate that the load has stalled.

If the soft starter frequently trips on excess start time:

- check that the Current Limit setting is high enough for the application
- check that the Excess Start Time setting is long enough for the application
- check that the load has not stalled or increased since the soft starter was installed

5.3.2 Motor Overload Protection

The ASAC-1 will trip on motor overload if it calculates that the motor has been running above its operating range for longer than the time selected in the Motor Trip Class setting. Motor Trip Class should be set to match the motor's locked rotor time. If this information is not available from the motor datasheet, use the default setting (Motor Trip Class = 10). Using a higher setting can damage the motor.



NOTE

Motor overload protection does not protect the soft starter, and does not protect the motor from short circuit.

5.3.3 Current Imbalance Protection

The ASAC-1 will trip on current imbalance if the highest and lowest currents on the three phases vary by an average of 30% for more than 3 seconds. Current imbalance protection is not adjustable, and is only active when the average motor current is 50% or more of the programmed motor FLC.

If the soft starter frequently trips on current imbalance:

- check that there is no imbalance on the mains voltage (on the input side of the soft starter)
- insulation test the motor
- move all input cables over one position (move L1 cable to L2, move L2 cable to L3, move L3 cable to L1) to rule out a cabling fault

5.3.4 Supply Frequency Protection

The soft starter will trip on supply frequency if the frequency rises above 72 Hz or falls below 40 Hz for more than five seconds while the soft starter is running. These trip points are not adjustable.

In pre-start, starting and stopping modes the high and low frequency limits both apply with no time delay.

A supply frequency trip will also occur if:

- all three input phases are lost while the soft starter is running
- all three input phases fall below 120 VAC at start or while the soft starter is running
- the line contactor opens while running

5.3.5 Bypass Overload Protection

Bypass overload protection protects the soft starter from severe operating overloads while running. The protection is not adjustable and has two components:

- The soft starter will trip if it detects overcurrent at 600% of the programmed motor full load current.
- The soft starter models the temperature of the internal bypass relays and will trip if the temperature exceeds the safe operating level.

If the trip occurs frequently, this indicates that the soft starter has not been selected correctly for the application.

5.4 Reset

Trips can be cleared by pressing the Reset button on the soft starter, sending a Reset command from the serial communications network, or by switching the control inputs.

To clear a trip via the control inputs, the soft starter requires a closed to open transition on the stop input (O2).

- In three-wire control, use the external stop button to momentarily open the stop input (open A1-O2).
- In two-wire control, if the soft starter tripped with a start signal present, remove the start signal (open A1 to O1, O2).
- In two wire control, if the ASAC tripped with no start signal present (eg ASAC-1 motor thermistor trip), apply then remove the start signal (close then reopen A1 to O1, O2).

The Reset button is located on the front of the unit, above the adjustment switches.

The soft starter will trip again immediately if the cause of the trip still exists.

6 Accessories

6.1 Finger Guard Kit

Finger guards may be specified for personnel safety. Finger guards fit over the soft starter terminals to prevent accidental contact with live terminals. Finger guards provide IP20 protection when used with cable of diameter 22 mm or greater.

6.2 Remote Operator

The Remote Operator can control and monitor the soft starter's performance. Functionality includes:

- Operational control (Start, Stop, Reset, Quick Stop)
- Starter status monitoring (Ready, Starting, Running, Stopping, Tripped)
- Performance monitoring (motor current, motor temperature)
- Trip code display
- 4-20 mA analog output (Motor Current)

6.3 Communication Modules

ASAC-1 soft starters support network communication via easy-to-install communications modules. Each soft starter can support one communications module at a time.

Available protocols:

Ethernet (Profinet, Modbus TCP, Ethernet/IP), Profibus, DeviceNet, Modbus RTU, and USB.



NOTE

Ethernet communication modules are not suitable for use with ASAC starters using 380/440 V AC control voltage.

6.4 PC Software

WinMaster can be used with Santerno soft starters to provide the following functionality for networks of up to 99 soft starters:

- Operational control (Start, Stop, Reset, Quick Stop)
- Starter status monitoring (Ready, Starting, Running, Stopping, Tripped)
- Performance monitoring (motor current, motor temperature)

To use WinMaster with the ASAC-1, the soft starter must be fitted with a USB Module, Modbus Module or a Remote Operator.

7 Specifications

	AC53b 4-6:354 < 1000 metres		AC53b 4-20:340 < 1000 metres	
	40 °C	50 °C	40 °C	50 °C
ASAC-1/007	18 A	17 A	17 A	15 A
ASAC-1/015	34 A	32 A	30 A	28 A
ASAC-1/018	42 A	40 A	36 A	33 A
ASAC-1/022	48 A	44 A	40 A	36 A
ASAC-1/030	60 A	55 A	49 A	45 A
	AC53b 4-6:594 < 1000 metres		AC53b 4-20 580 < 1000 metres	
	40 °C	50 °C	40 °C	50 °C
ASAC-1/037	75 A	68 A	65 A	59 A
ASAC-1/045	85 A	78 A	73 A	67 A
ASAC-1/055	100 A	100 A	96 A	87 A
ASAC-1/075	140 A	133 A	120 A	110 A
ASAC-1/090	170 A	157 A	142 A	130 A
ASAC-1/110	200 A	186 A	165 A	152 A

7.1 Semiconductor Fuses

Semiconductor fuses can be used with ASAC-1 soft starters to reduce the potential for damage to SCRs from transient overload currents and for Type 2 coordination. ASAC-1 soft starters have been tested to achieve Type 2 coordination with semiconductor fuses. Suitable Bussmann and Ferraz/Mersen semiconductor fuses are detailed below.

Model	SCR I ² t (A ² s)	Ferraz/Mersen Fuse European/IEC Style (North American Style)	Bussmann Fuse Square Body (170M)	Bussmann Fuse British Style (BS88)
ASAC-1/007	1150	6.6URD30xxxA0063 (A070URD30xxx0063)	170M-1314	63 FE
ASAC-1/015	8000	6.6URD30xxxA0125 (A070URD30xxx0125)	170M-1317	160 FEE
ASAC-1/018	10500	6.6URD30xxxA0160 (A070URD30xxx0160)	170M-1318	160 FEE
ASAC-1/022	15000	6.6URD30xxxA0160 (A070URD30xxx0160)	170M-1318	180 FM
ASAC-1/030	18000	6.6URD30xxxA0160 (A070URD30xxx0160)	170M-1319	180 FM
ASAC-1/037	51200	6.6URD30xxxA0250 (A070URD30xxx0250)	170M-1321	250 FM
ASAC-1/045	80000	6.6URD30xxxA0315 (A070URD30xxx0315)	170M-1321	250 FM
ASAC-1/055	97000	6.6URD30xxxA0315 (A070URD30xxx0315)	170M-1321	250 FM
ASAC-1/075	168000	6.6URD31xxxA0450 (A070URD31xxx0450)	170M-1322	500 FMM
ASAC-1/090	245000	6.6URD31xxxA0450 (A070URD31xxx0450)	170M-3022	500 FMM
ASAC-1/110	320000	6.6URD31xxxA0450 (A070URD31xxx0450)	170M-3022	500 FMM

xxx = Blade Type. Contact Ferraz/Mersen for options.

7.2 General Technical Data

Mains Supply

Mains voltage (L1, L2, L3)	
4	3 x 200 VAC ~ 440 VAC (+ 10% / - 15%)
5	3 x 200 VAC ~ 575 VAC (+ 10% / - 15%)
Mains frequency (at start)	45 Hz to 66 Hz
Rated insulation voltage	600 VAC
Form designation	Bypassed semiconductor motor starter form 1

Control Voltage (A1, A2, A3)

ASAC-1/xxx/x/1	110-240 VAC (+ 10% / - 15%) or 380-440 VAC (+ 10% / - 15%)
ASAC-1/xxx/x/2	24 VAC/VDC (± 20%)
Current consumption (during run)	< 100 mA
Current consumption (inrush)	
ASAC-1/xxx/x/1	10 A
ASAC-1/xxx/x/2	2 A

Inputs

Start (terminal 01)	Normally open
	150 kΩ @ 300 VAC and 5.6 kΩ @ 24 VAC/VDC
Stop (terminal 02)	Normally closed
	150 kΩ @ 300 VAC and 5.6 kΩ @ 24 VAC/VDC

Outputs

Main contactor relay (terminals 13, 14)	Normally open
	6 A, 30 VDC / 6 A, 250 VAC resistive
Programmable relay (terminals 23, 24)	Normally open
	6 A, 30 VDC / 6 A, 250 VAC resistive

Environmental

Degree of Protection ASAC-1/007 to ASAC-1/055	IP20
Degree of Protection ASAC-1/075 to ASAC-1/110	IP00
Operating temperature	- 10 °C to + 60 °C
Storage temperature	-25 °C to + 60 °C (to +70 °C for less than 24 hours)
Humidity	5% to 95% Relative Humidity
Pollution degree	Pollution Degree 3
Vibration	IEC 60068 Test Fc Sinusoidal
	4 Hz to 13.2 Hz: ± 1 mm displacement
	13.2 Hz to 200 Hz: ± 0.7 g

EMC Emission

Equipment class (EMC)	Class B
Conducted radio frequency emission	0.15 MHz to 0.5 MHz: < 56-46 dB (µV)
	0.5 MHz to 5 MHz: < 46 dB (µV)
	5 MHz to 30 MHz: 50 dB (µV)
Radiated radio frequency emission	30 MHz to 230 MHz: < 30 dB (µV/m)
	230 MHz to 1000 MHz: < 37 dB (µV/m)

EMC Immunity

Electrostatic discharge	4 kV contact discharge, 8 kV air discharge
Radio frequency electromagnetic field	0.15 MHz to 1000 MHz: 140 dB (µV)
Rated impulse withstand voltage (Fast transients 5/50 ns)	2 kV line to earth, 1 kV line to line
Voltage dip and short time interruption	100 ms (at 40% nominal voltage)
Harmonics and distortion	IEC61000-2-4 (Class 3), EN/IEC61800-3
	EAC TP TC 020/2011

Short Circuit

Rated short-circuit current ASAC-1/007 to ASAC-1/022	5 kA ¹
Rated short-circuit current ASAC-1/030 to ASAC-1/110	10 kA ¹

¹ These short circuit ratings are with fuses used as given in the table under *Semiconductor Fuses* on page 9

Heat Dissipation

During Start	3 watts / ampere
During Run	10 watts typical

Approvals

C✓ IEC 60947-4-2
 CE IEC 60947-4-2
 EAC (formerly GOST) TP TC 004/2011
 RoHS Compliant with EU Directive 2002/95/EC
 UL / C-UL UL 508

Operational Life

ASAC-1/007~055 1,000,000 operations
 ASAC-1/075~110 30,000 operations

7.3

Model Code

ASAC-1/ / /

Control voltage
 1 = 110-240 VAC & 380-440 VAC
 2 = 24 VAC/VDC

Mains voltage
 4 = 200 ~ 440 VAC
 5 = 200 ~ 575 VAC

Nominal kW rating @400 VAC
 007~030: AC53b 4-6-354
 037~110: AC53b 4-6-594

